

Systems Protector



Protects essential systems while maintaining accessibility.

Are you tired of runaway pallets, stock carts and forklifts banging up the electrical, plumbing, refrigeration and information systems that are critical to keeping your business running? CartStop Systems Protector provides reliable protection from damaging blows, saving you money on costly repairs, while allowing full access to your systems when needed.

Tough Heavy-duty steel construction with safety yellow powder coat finish is impact resistant to warehouse equipment

Shock Absorbing Steel cross members safely protect critical systems, yet can be easily removed to allow access for maintenance and service

Speedy Install Self-threading concrete anchors eliminate the need for messy adhesives or quick-set cement

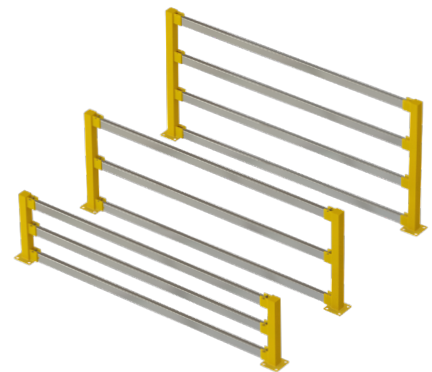

Systems Protector

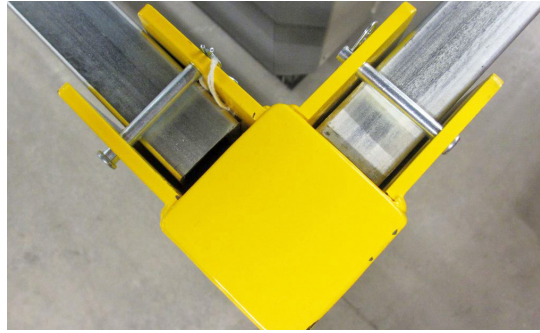

Specifications:

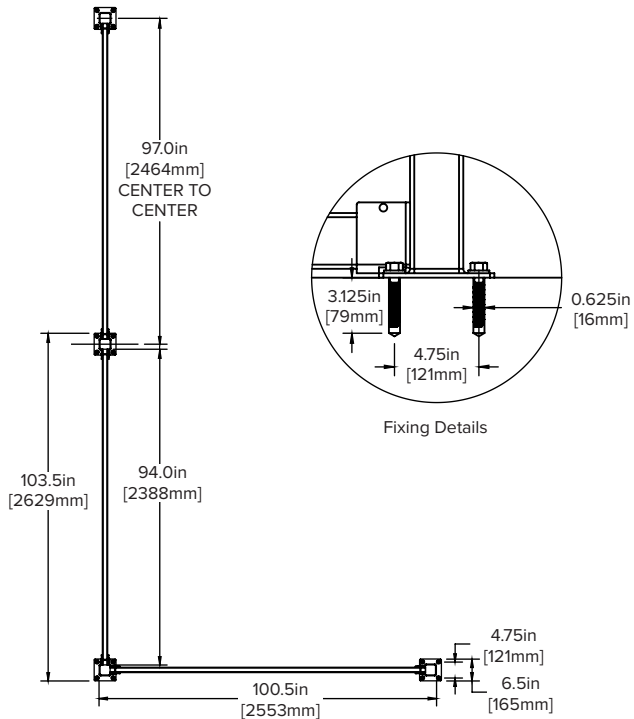

24" Systems Protector Height:

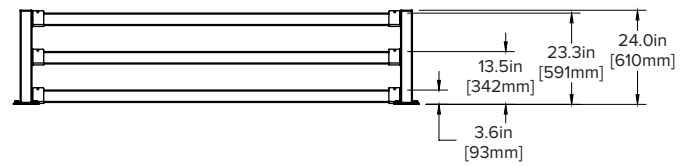

36" Systems Protector Height:

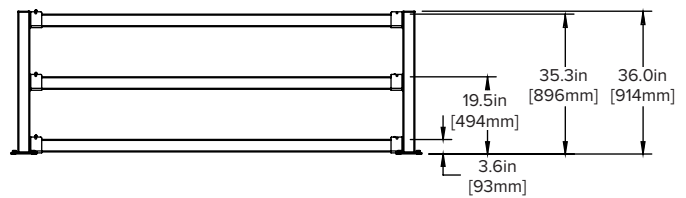

48" Systems Protector Height:

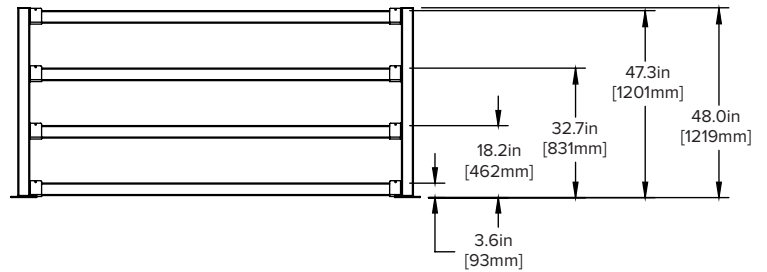

Components:

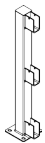

End

Hardware included—all uprights ship with concrete anchors

24" PART #: CSSYP-24E-KIT

36" PART #: CSSYP-36E-KIT

48" PART #: CSSYP-48E-KIT

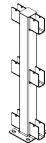

Middle

Hardware included—all uprights ship with concrete anchors

24" PART #: CSSYP-24M-KIT

36" PART #: CSSYP-36M-KIT

48" PART #: CSSYP-48M-KIT

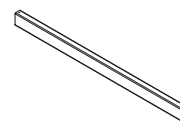

Box Rail 8' Length

Electroplated Cold Rolled Steel

PART #: CSB-94

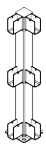

Corner

Hardware included—all uprights ship with concrete anchors

24" PART #: CSSYP-24C-KIT

36" PART #: CSSYP-36C-KIT

48" PART #: CSSYP-48C-KIT



5/8" Concrete Anchor

3 inches long, self threading, & with anti-rotation serrations to prevent back-out

Red Head 5/8" x 3" LDT

Lead Time:

2 week lead for quantity up to 25. Inquire for quantities 25 or more.

Standard Colors:

Safety Yellow